

Article number: 20652046

Description: E+G Centring bore clamp GN 411.2-70.5-K

Measures

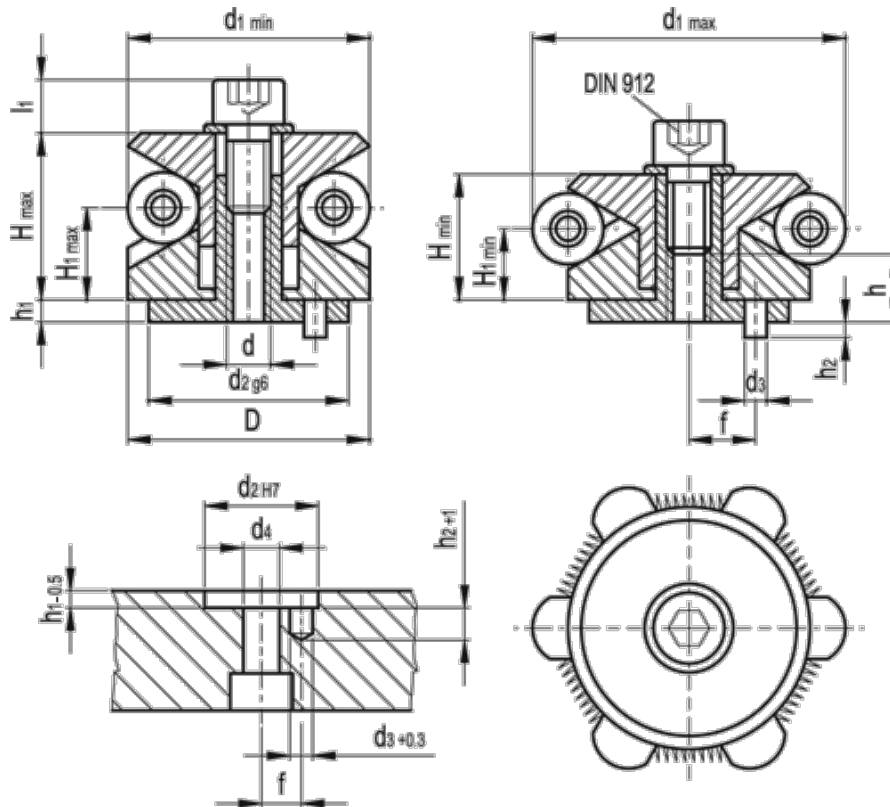

Clamping force (kN) = 10.00	d4 = 13.0	H min = 33.3
Clamping points = 6	f +/-0.1 = 17.0	l1 = 16.5
D = 70.5	h1 = 5.0	Weight (g) = 1267
d = M12	H1 max = 25.3	
d1 max = 86.5	H1 min = 20.6	
d1 min = 70.5	h2 = 9.5	
d2 g6/H7 = 60	H max = 42.6	
d3 = 5.0	h min = 20	